

## CONTENTS

Pos	Name	Art no	Pcs
1	StoneGuard Honeycomb	TSS-SG-1001-A	1
2	Honeycomb Lid Cover RH	TSS-SG-1002-A	1
3	Honeycomb Lid Cover LH	TSS-SG-1003-A	1
4	Cab Bracket	TSS-SG-1005-A	2
5	Flange screw M6x16	TSS-SG-1013-P	2
6	Flange nut M6	TSS-SG-1020-P	1

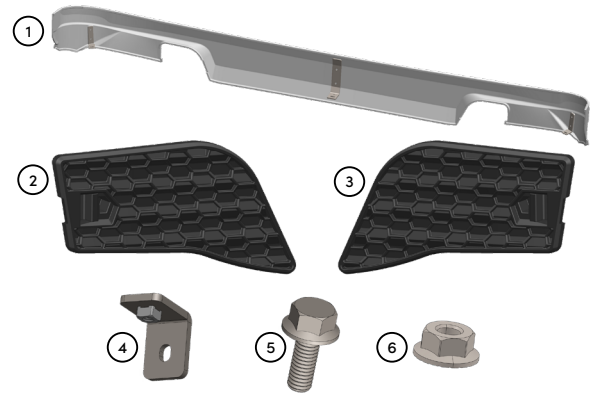

### IMPORTANT!

All installations should be done by experienced mechanics. In the event of your own modifications or making holes in the product, the warranty expires. TruckStyle Sweden AB does not take responsibility for any damage that occurs in the event of an incorrect installation.



### Before installation

Remove Cover RH (TSS-SG-1002-A) and Cover LH (TSS-SG-1003-A) from StoneGuard.

1. Open front service hatch.
2. Open side hatches.
3. Loosen screws and remove handle.

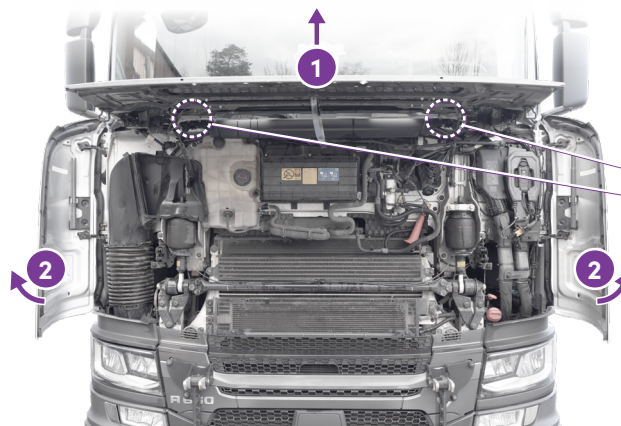

Lower down service hatch to simplify removal of the handle.

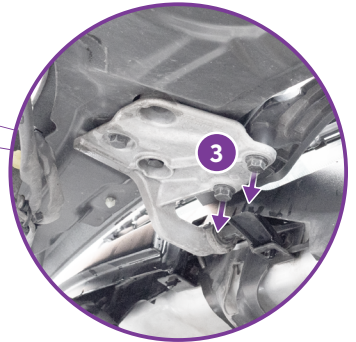

4. Loosen screw in center bracket and remove upper center panel (the screw is not re-used).
5. Detach upper side panels (Clips only) on both sides.

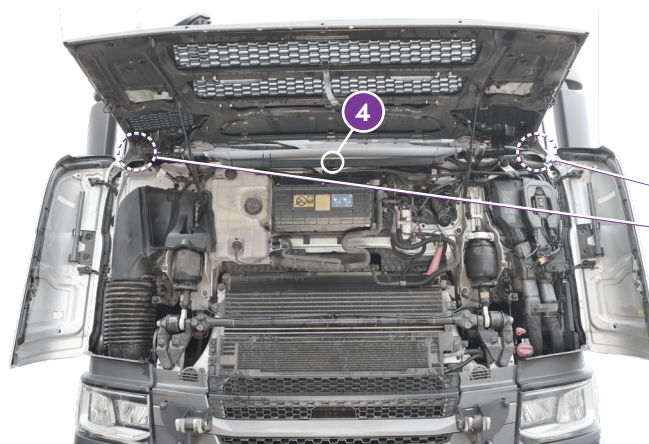

Lower down service hatch to simplify removal of the panels.



6. Loosen screw (the screw is re-used).
7. Place Cab Bracket (TSS-SG-1005-A).
8. Enter screw and tighten slightly, so that the bracket can still rotate with some friction.

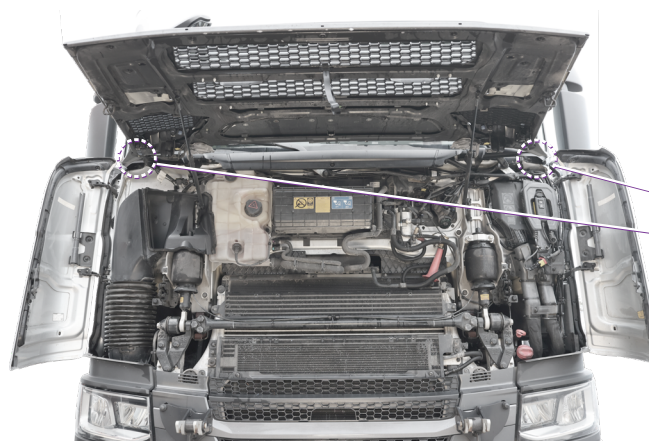

Performed on both sides.

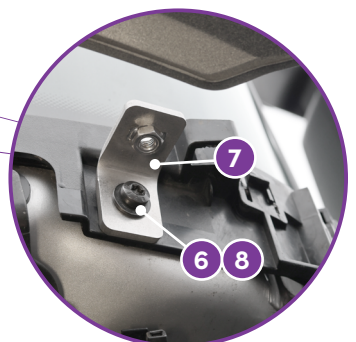

9. Place StoneGuard. Lower down service hatch slightly to simplify placement of StoneGuard. Make sure the threaded pin slots into Truck centre bracket.
10. Enter screw (TSS-SG-1013-P) on both sides.
11. Enter nut (TSS-SG-1020-P) on center bracket.



! Screw on slightly.

12. Push StoneGuard against side post and at the same time tighten screw (TSS-SG-1013-P) with 7Nm.
13. Tighten screw for Cab Bracket with 7Nm.

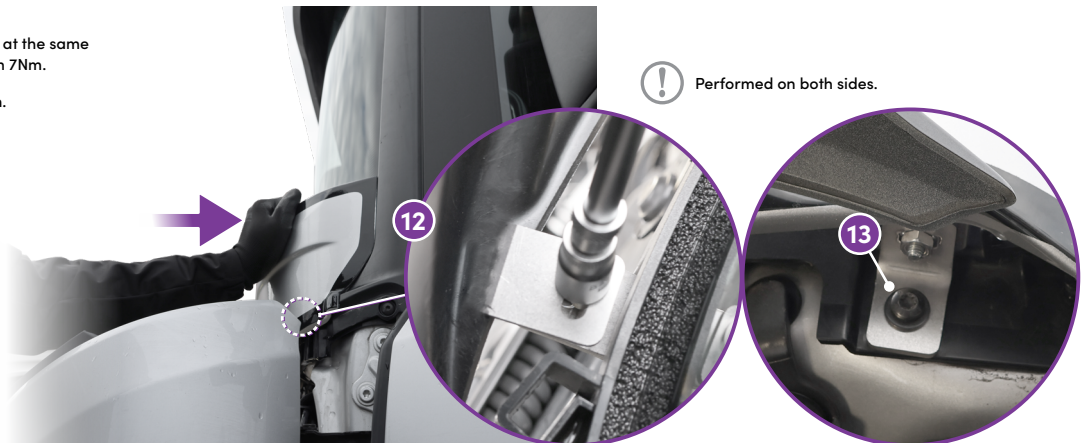

! Performed on both sides.

14. Carefully open and close service hatch to check clearance to StoneGuard. There should be a minimum of 1-2mm clearance.
15. Tighten nut in center bracket with 7Nm.
16. Test windscreen wipers to check clearance to StoneGuard.



When StoneGuard is mounted we recommend to secure screws with Loctite 271 or similar.

17. Attach Cover RH (TSS-SG-1002-A) on right side and Cover LH (TSS-SG-1003-A) on left side. Check that the spring-loaded lock engage and secures the covers in place.



**! IMPORTANT!**  
Covers must always be removed before service hatch is opened. To prevent damage on covers and StoneGuard.



StoneGuard installation instruction video is available on YouTube.  
<https://www.youtube.com/@truckstylesweden9904>